

Article number: 439500160
 Description: Rota-fix shaft-hub connection F160x210
 Steel
 Note: Self centering. Very high torque

Measures

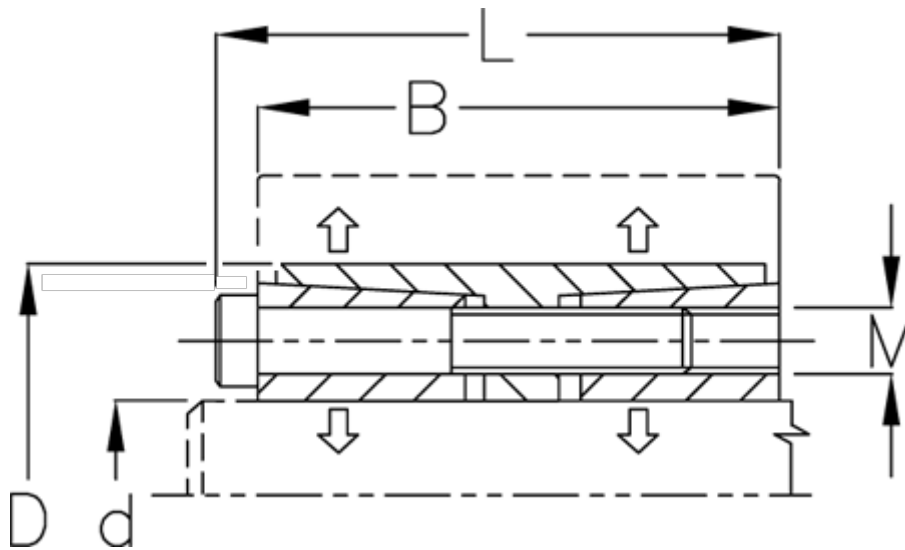

B mm	= 114
d H8 mm	= 160
D mm	= 210
Fit tolerance	= Aksel h8, Nav H8
F kN torque	= 900.0
L mm	= 128
M mm	= M14
P N/mm ² surface pressure on shaft/hub	= 110

Surface roughness	= R? ? 3.2 μ m
T N m torque	= 75000
Ts N m bolt tightening torque	= 230.0